

## Exhaust System Installation For Dodge Charger SE



**These instructions have been written to help you with the installation of your Borla Performance Exhaust System. Please read this document completely before beginning the installation of your system.**

**Please compare the parts in the box with the bill of materials provided to assure that you have all the parts necessary for this installation.**

**To ensure this part number fits your specific model year, please visit our website for the latest model year listings at [www.BORLA.com](http://www.BORLA.com).**

**Thank you for purchasing a Borla Performance Cat-Back™ Exhaust System.**

**These Borla Performance Cat-Back™ Exhaust Systems (Part number 140448) is designed for the Dodge Charger SE equipped with a 3.6L V6 engine, rear-wheel drive and an automatic transmission.**

Borla Performance Industries recommends that an exhaust shop or professional after market parts installer, who has all the necessary equipment, tools and experienced personnel needed for proper installation, should perform the installation of this system. However, if you decide to perform the installation, we recommend someone should help you. Ensure the installer uses all under car safety precautions including eye protection.

*Please take time to read and understand the following...*

By installing your Borla Performance Exhaust System, you indicate that you have read this document and you agree with the terms stated below.

It is the responsibility of the purchaser to follow all installation instruction guidelines and safety procedures supplied with your Borla Performance Exhaust System

Borla Performance Industries assumes no responsibility for damages occurring from misuse, abuse, improper installation, improper operation, lack of responsible care, or all previously stated reasons resulting from incompatibility with other manufacturer's products and/or systems.

Included with your Borla Performance Exhaust System is a warranty card. Please read it carefully before you begin any work on your vehicle. If you should have any questions regarding our warranty policy, installation, or any other matter pertaining to your new Borla Performance Exhaust System, please give us a call at the number provided on the warranty card.

**Minimum Required Tool List:**

**TOOLS:**

1. 3/8" Drive Ratchet
2. 3/8" Drive Extension 3"
3. 15mm Deep Well Socket
4. Pry Bar

**SHOP SUPPLIES:**

- 1 Spray Lubricant

**Borla Performance Cat-back™ Bill of Materials**

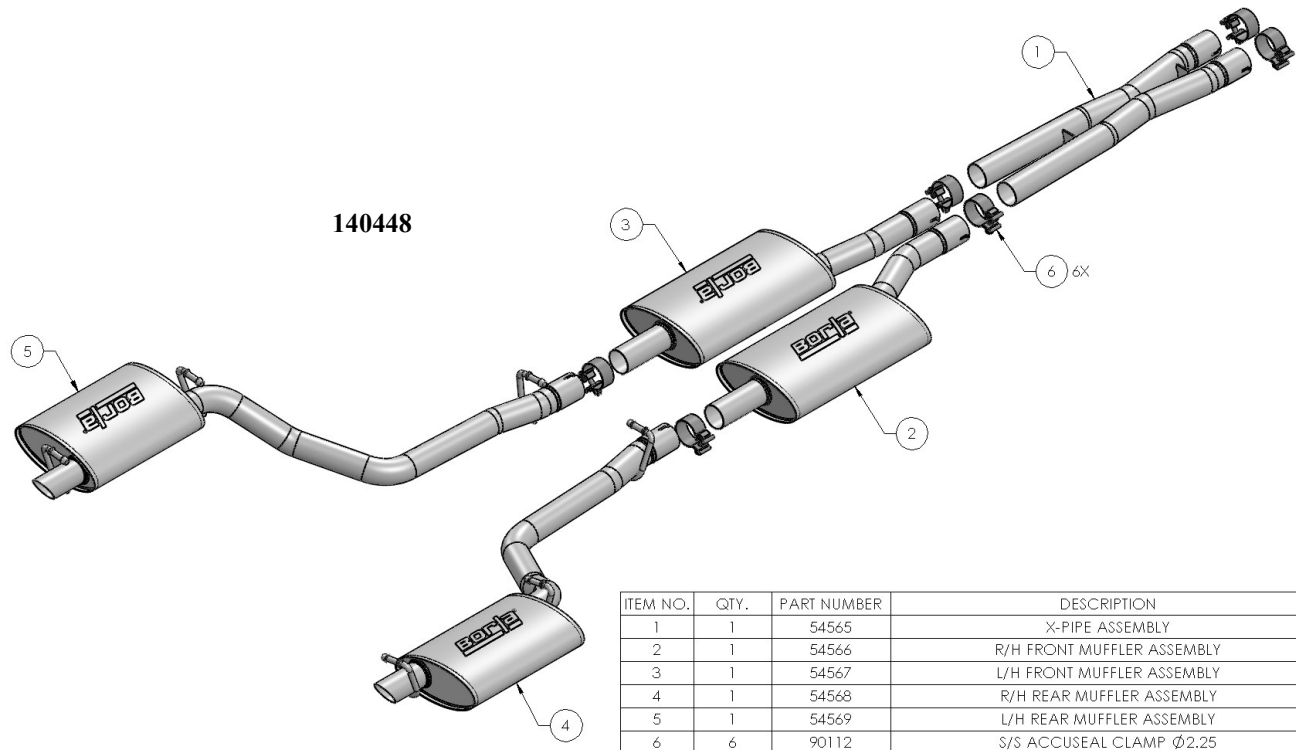

ITEM NO.	QTY.	PART NUMBER	DESCRIPTION
1	1	54565	X-PIPE ASSEMBLY
2	1	54566	R/H FRONT MUFFLER ASSEMBLY
3	1	54567	L/H FRONT MUFFLER ASSEMBLY
4	1	54568	R/H REAR MUFFLER ASSEMBLY
5	1	54569	L/H REAR MUFFLER ASSEMBLY
6	6	90112	S/S ACCUSEAL CLAMP Ø2.25

**Caution!!! Never work on a hot exhaust system. Serious injury in the form of burns can result** If the vehicle has been in use and the exhaust system is hot, allow vehicle to cool for at least 1 hour. Always wear eye protection when working under any vehicle.

*Note: It is our recommendation that you use a hoist or hydraulic lift to facilitate the installation of your new Borla Performance Rear Section Exhaust System.*

Taking all under car safety precautions, lift the vehicle using a hoist or hydraulic lift. Once this has been done, you may begin the removal of your old exhaust system from your vehicle.

*Note: Before removing the original exhaust system from your vehicle, please compare the parts you have received with the bill of materials provided on the previous page to assure that you have all the parts necessary for the installation of your new Borla Performance Rear Section Exhaust System.*

## Original Exhaust System Removal

*Note: With a used vehicle, we suggest a penetrating spray lubricant to be applied liberally to all exhaust fasteners and allowing a significant period of time for the chemical to lubricate the threads before attempting to disassemble.*

1. Unclip and remove the ground strap shown in located on the R/H side rear muffler hangar.
2. Lubricate all hangers and rubber isolators.
3. Remove both cross braces by loosening and removing hardware. Keep hardware for reinstallation later. (See Fig.1)
4. Loosen clamp bolts on the left-side and right-side pipes in front of the factory Y-Pipe. (See Fig. 2)
5. Loosen clamp bolt at rear Y-Pipe. (See Fig. 3)
6. Using a muffler stand or an additional person to hold the front assembly, remove the hangers from the rubber isolators and remove the left-side rear muffler assembly from the vehicle. Repeat for the right-side rear muffler assembly. (See Fig. 4)
7. Remove the mid-pipe assembly.

**Warning: Use extreme caution during installation. Torque all fasteners according to manufacturer's torque values and tightening sequence. DO NOT use air impact tools to tighten fasteners on Borla Performance Exhaust Systems. Use of such tools may result in bent flanges or gasket contact areas**

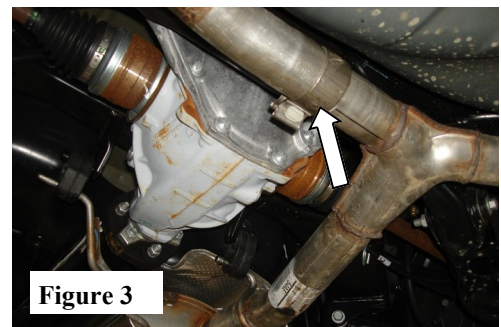
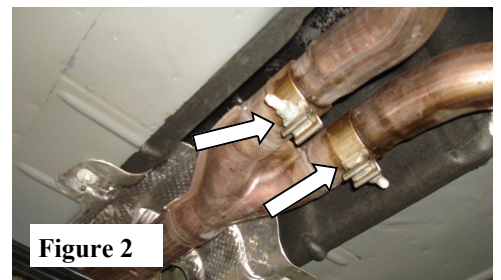
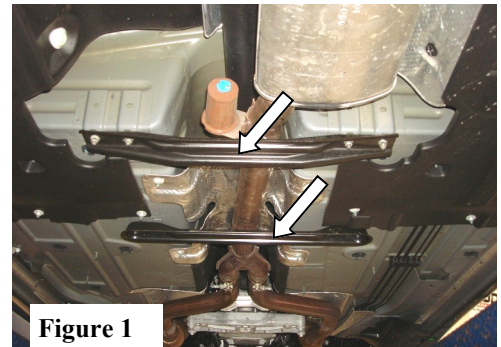

## Borla Performance Cat-Back™ Exhaust System Installation

1. Place a clamp over each expanded end of the X-pipe assembly and place over factory front pipes. Insert hangers into rubber isolators. (See Fig. 5) Do Not tighten clamps
2. Place a clamp over the expanded end of both L/H Front Muffler Assembly and place over left X-Pipe outlet. Repeat for R/H Front Muffler Assembly. (See Fig. 5) Do Not tighten the clamps
3. Place a clamp over the expanded end of L/H Rear Muffler Assembly and place over L/H Front Muffler Assembly outlet making sure to install the hangers into the rubber isolators. (See Fig.6) Do Not tighten the clamps
4. Clip the ground strap onto the hanger located just in front of the R/H Rear Muffler.
5. Check your exhaust system for proper clearance under the vehicle and also for tip alignment.
6. Once position has been determined to be correct, tighten the Accuseal clamps to 32-35 ft. lbs. (See Fig. 7)
7. Before starting your vehicle, make sure to check all wires, hoses, brake lines, body parts and tires for safe clearance from the exhaust system.
8. Start vehicle and check for any leaks. If any leaks are found, determine cause (such as loose or incorrectly positioned clamp) and repair as necessary.

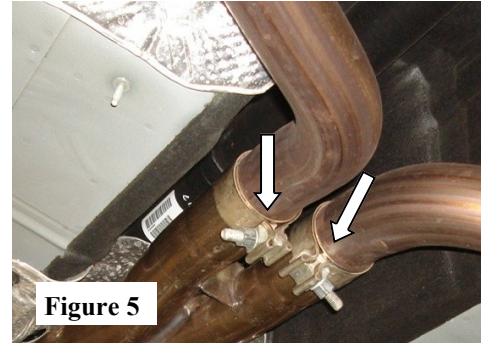
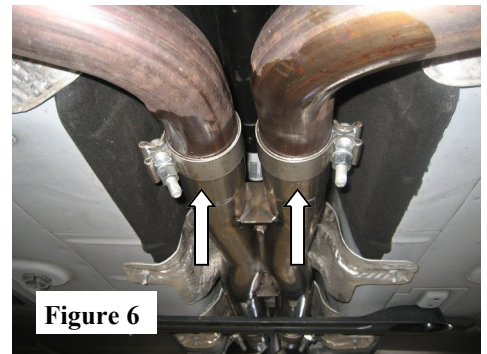
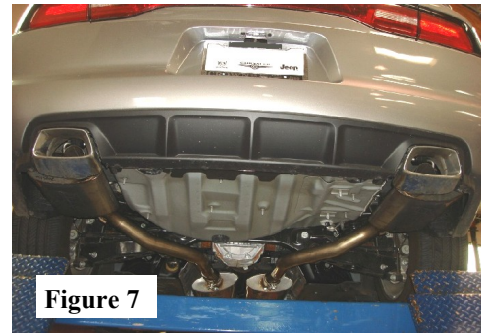
**Figure 5****Figure 6****Figure 7**

*Note: When you first start your vehicle after the installation of your new Borla Performance Exhaust System, there may be some smoke and fumes coming from the system. This is a protective oil based coating used in the manufacturing of mandrel bent performance exhaust tubing. This is not a problem and will disappear within a very short period of time after the exhaust has reached normal operating temperatures.*